

# SCHOCK



**SINA**  
515000



[www.schock.de/easy-sina](http://www.schock.de/easy-sina)





## PRODUKTMERKMALE PRODUCT SPECIFICATIONS



**450**  
**17<sup>3</sup>/<sub>4</sub>"**  
Anschluss Schlauchlänge  
Length of supply hoses



**3/8"**  
Gewindegröße Anschluss Schlauch  
Thread size of supply hose



**Rückflussverhinderer**  
Quarter turn valve



**Schwenkbereich**  
Swivel range



**Wasserdruck**  
Water pressure



0,5 max 10

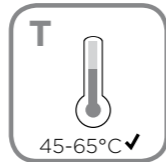

**Temperatur**  
Temperature



max 80



**Wasserdurchflussmenge**  
Water flow rate



l/min



## SICHERHEITSHINWEISE SAFETY NOTES

### SCHOCK

- DEU** DIE GEWÄHRLEISTUNG VERFÄLLT BEI LAIENMONTAGE. SCHOCK EMPFIEHLT DIE VERWENDUNG DES GROBPARTIKELFILTERS SF-100 (629883). KEINEN CHLORREINIGER VERWENDEN.
- ENG** THE WARRANTY IS VOIDED BY NON-PROFESSIONAL INSTALLATION. SCHOCK RECOMMENDS THE USE OF THE SF-100 (629883) COARSE PARTICLE FILTER. DO NOT USE CHLORINE-BASED CLEANING AGENTS.
- ES** LA GARANTÍA CADUCA CUANDO EL MONTAJE NO ES REALIZADO POR PERSONAL ESPECIALIZADO. SCHOCK RECOMIENDA LA INSTALACIÓN DEL FILTRO CONTRA PARTÍCULAS GRUESAS SF-100 (629883). SE ADVIERTE NO UTILIZAR DETERGENTES QUE CONTENGAN CLORO.
- TR** YETKİLİ KİŞİLERCE YAPILMAYAN MONTAJLARDA GARANTİ GEÇERSİZ SAYILACAKTIR. SCHOCK SF-100 (629883) KALIN PARÇACIK FİLTRESİNİ KULLANMANIZI ÖNERİR. ASLA KLORLU TEMİZLEYİCİLER KULLANMAYINIZ.
- POL** GWARANCJA TRACI WAŻNOŚĆ W PRZYPADKU NIEWŁAŚCIWEGO MONTAŻU. SCHOCK ZALECA UŻYCIĘ ZAWORU KĄTOWEGO Z FILTREM SF-100 (629883). NIE STOSOWAĆ ŚRODKÓW NA BAZIE CHLORU.
- RUS** ГАРАНТИЯ РАСПРОСТРАНЯЕТСЯ НА СМЕСИТЕЛИ УСТАНОВЛЕННЫЕ КВАЛИФИЦИРОВАННЫМ САНТЕХНИКОМ. SCHOCK РЕКОМЕНДУЕТ ИСПОЛЬЗОВАТЬ ФИЛЬТР ГРУБОЙ ОЧИСТКИ SF-100 (629883). НЕ ИСПОЛЬЗОВАТЬ ХЛОРСОДЕРЖАЩИЕ ЧИСТЯЩИЕ СРЕДСТВА.





## INSTALLATION INSTALLATION

3

**Anschlusschläuche an Eckventile anschrauben**  
Screw supply hoses onto angle valves

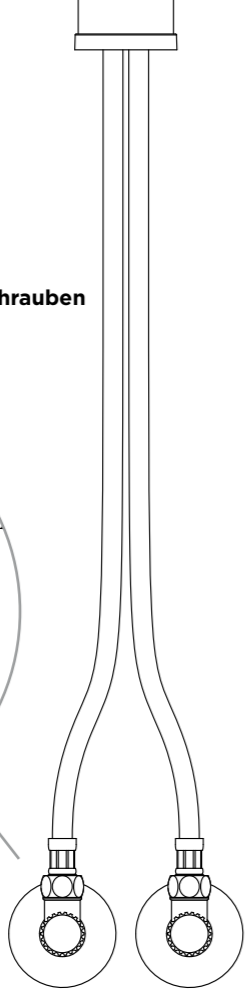
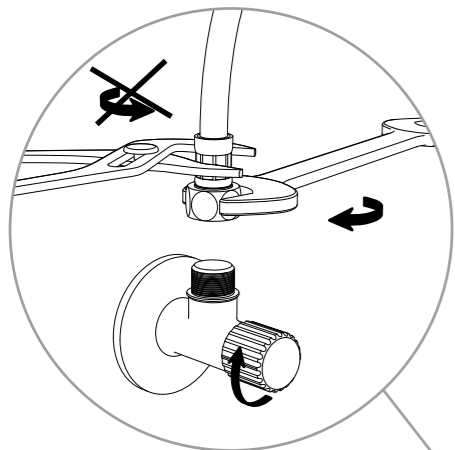

4

**Hebel öffnen und Brausekopf abschrauben**  
Open the handle and remove the shower head

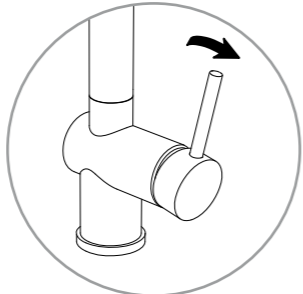

5

**Eckventile öffnen und alle Verbindungen auf Undichtheiten prüfen**  
Turn on water supplies and check connections for leaks

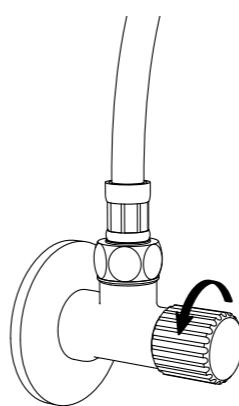

6

**Hebel schließen und Brausekopf wieder einbauen**  
Close the handle and re-install the shower head

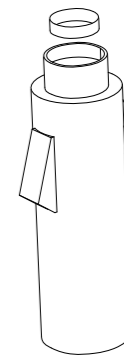
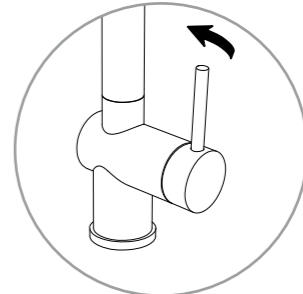

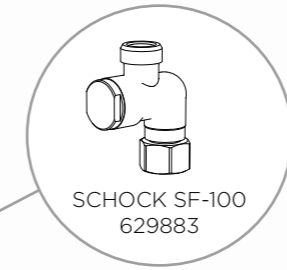
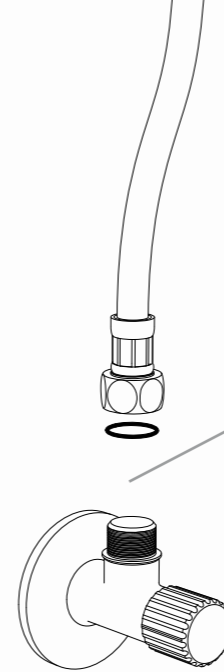
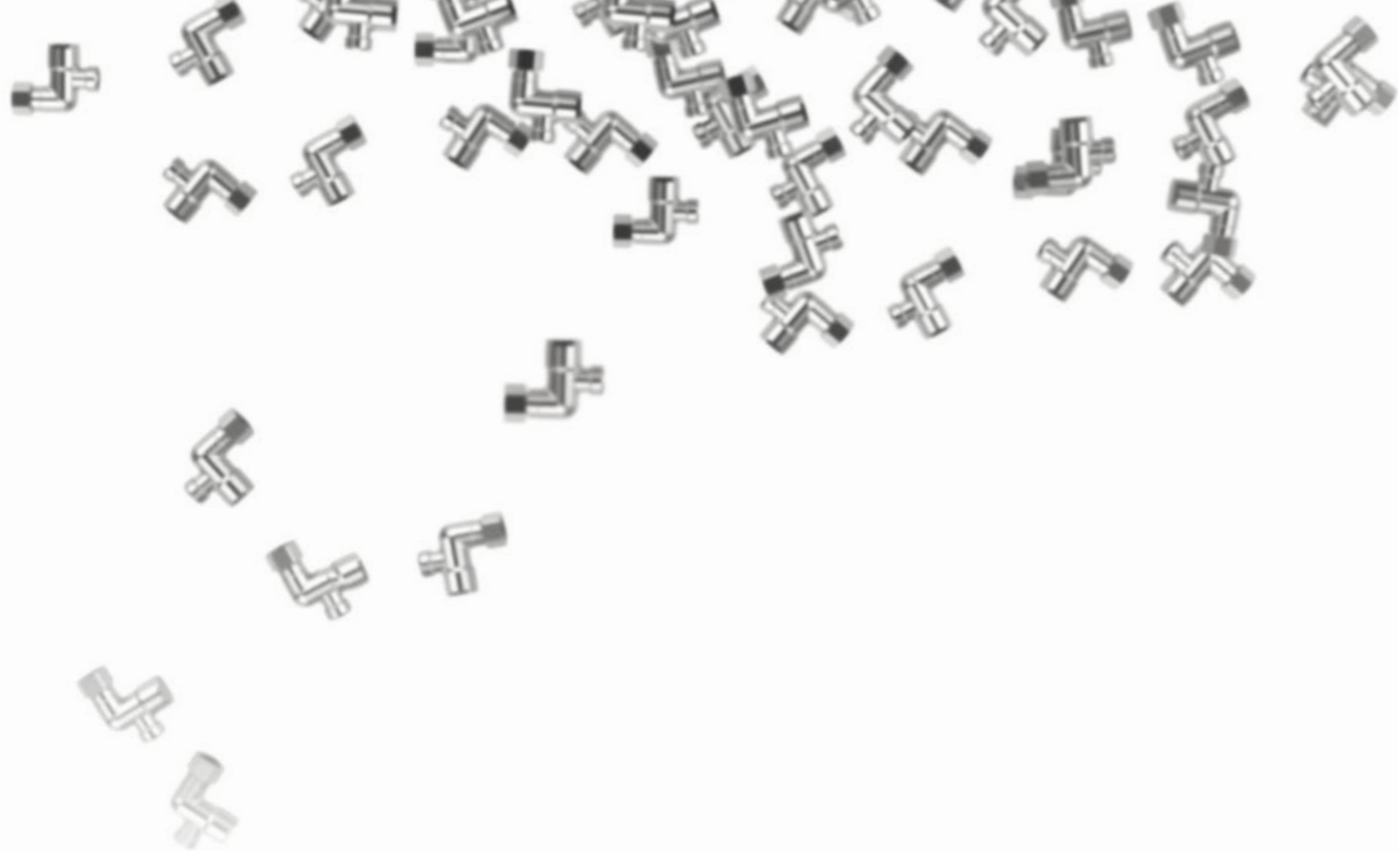

# BODYGUARD

**SF-100**

Auch in modernen Leitungssystemen werden im Wasser Sandkörner transportiert. Der SF-100 Grobpartikelfilter schützt die Kartusche und den Perlator einer hochwertigen Schock Armatur vor Beschädigungen.

Even modern plumbing systems transport grains of sand along with the water. The SF-100 coarse particle filter protects the cartridge and aerator in a premium Schock tap against damage.

[WWW.SCHOCK.DE/SF100](http://WWW.SCHOCK.DE/SF100)



**PFLEGEPRODUKTE**  
CARE PRODUCTS

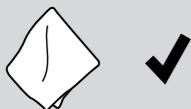
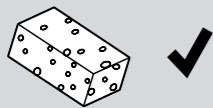

**PFLEGEHINWEISE**  
CARE INSTRUCTIONS

1.

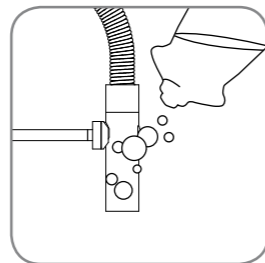

2.

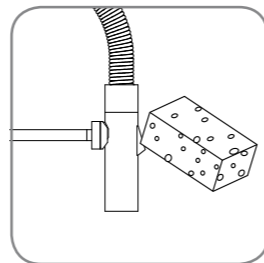

3.

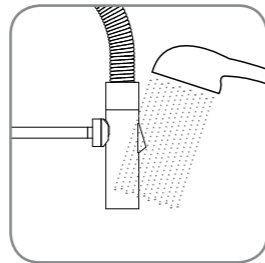

4.

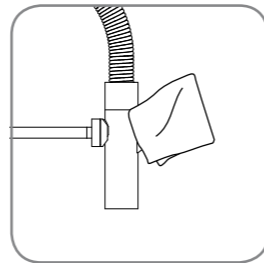

**WERKZEUGE**  
TOOLS



**PERLATORREINIGUNG**  
CLEANING THE AERATOR

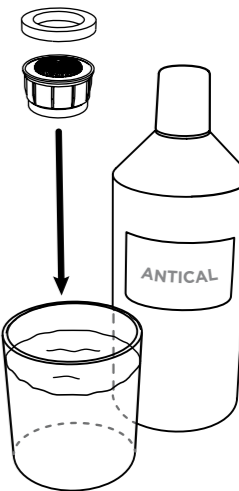
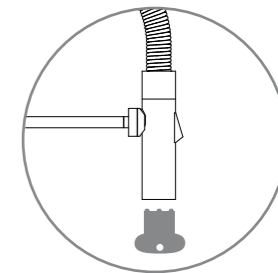

60 min



**WERKZEUGE**  
TOOLS



30 mm



**KARTUSCHENWECHSEL**  
CHANGING THE CARTRIDGE

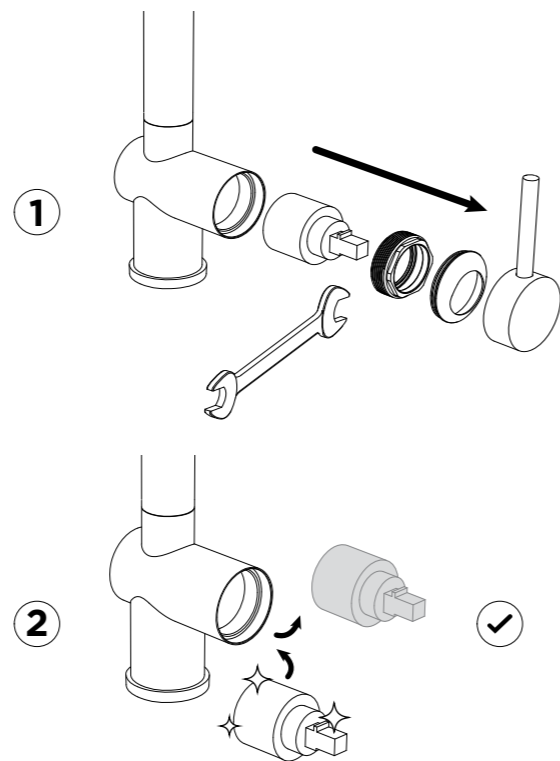

**SCHOCK**



**WEBSHOP**



[WWW.SCHOCK.DE/SHOP](http://WWW.SCHOCK.DE/SHOP)



## ERSATZTEILE SPARE PARTS

① 628778/1

② 628749/2

③ 628797/3

④ 628797EDM

⑤ 628797/7

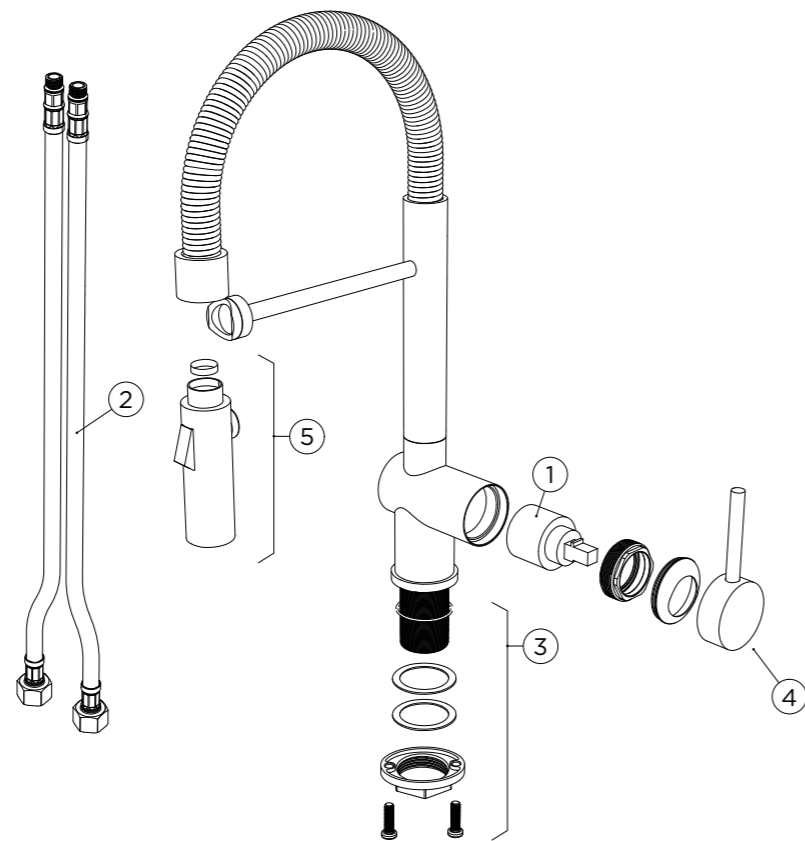

## MASSE MEASUREMENTS

### SCHOCK

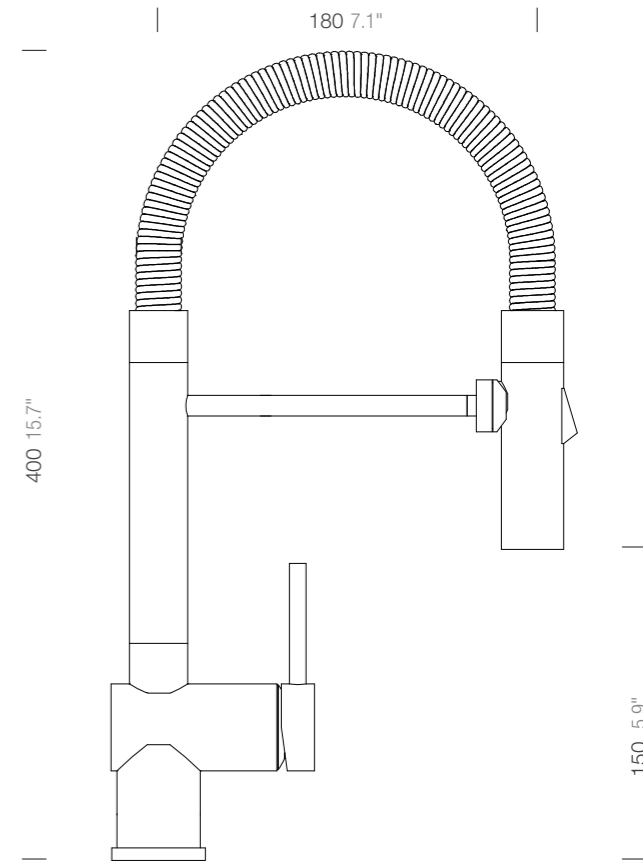





[www.schock.de/service](http://www.schock.de/service)



[www.schock.de/shop](http://www.schock.de/shop)

SCHOCK GmbH • Hofbauerstr. 1 • D-94209 Regen  
Telefon: +49-9921-600-0 • Fax: +49-9921-600-253

Email: [info@schock.de](mailto:info@schock.de) • [www.schock.de](http://www.schock.de)